

Sealed Rechargeable Ni-MH Cylindrical Cell

Specifications

Nominal voltage		1.2V	
Capacity (mAh)		0.2C discharge	0.5C discharge
	Minimum	3200	3150
	Typical	3240	3200
Dimensions (mm)	Diameter	17.0 ^{+0.0} _{-0.5}	
	Height	67.0 ^{+0.0} _{-1.0}	
Weight (g)	53		
Charge	Standard	320mA(0.1C)×16hrs	
	Rapid	1600mA(0.5C)×135mins or dV=-10mV	
Ambient temperature ()	Standard charge	0 to 45	
	Rapid charge	10 to 45	
	Discharge	-20 to 65	
	Storage	-10 to 45	

(CELL DIMENSIONS)

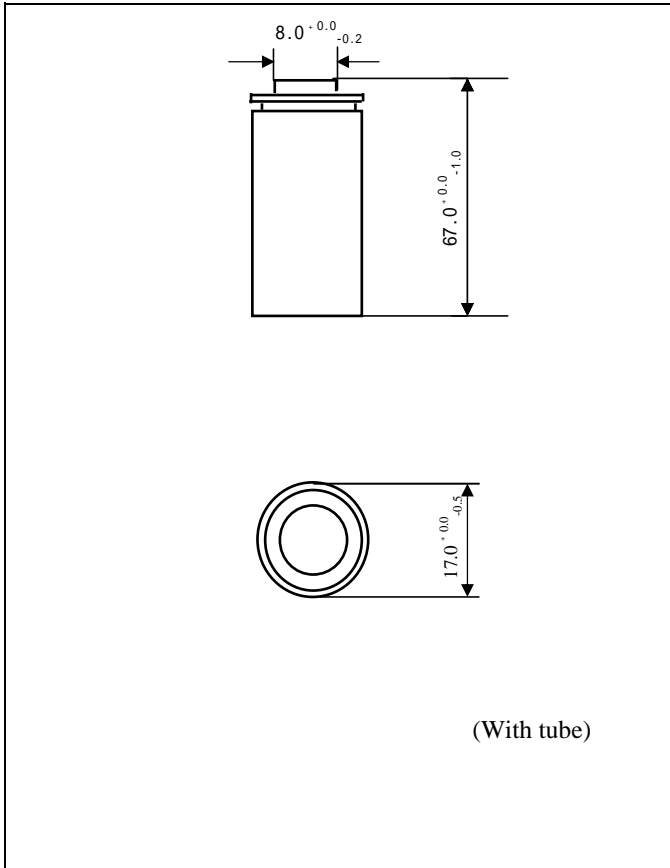

Charge Characteristics

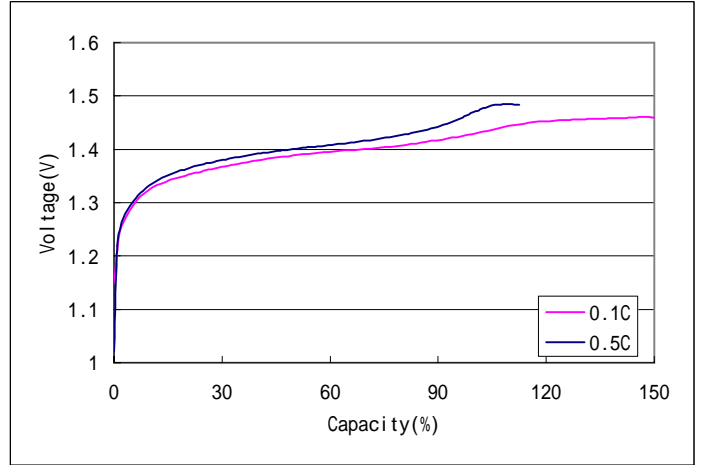

Discharge Characteristics

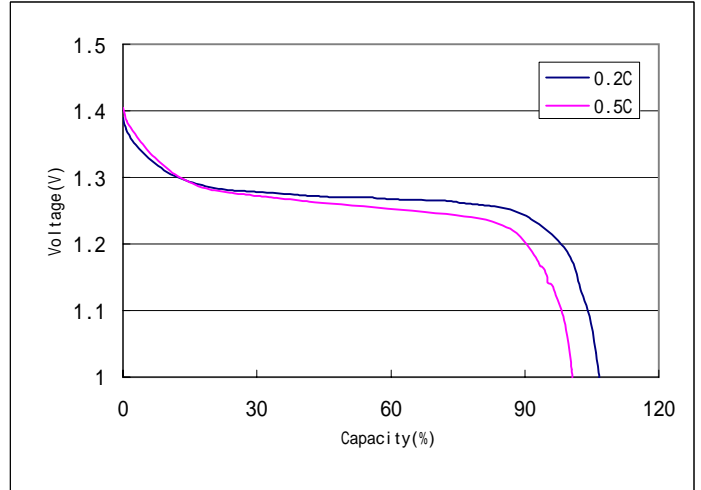

Cycle Characteristics

