

Sealed Rechargeable Ni-MH Cylindrical Cell

Specifications

Nominal voltage		1.2V	
Capacity (mAh)		0.2C discharge	1C discharge
	Minimum	340	320
	Typical	350	340
Dimensions (mm)	Diameter	$10.5^{+0.0}_{-0.5}$	
	Height	$28.5^{+0.0}_{-1.0}$	
Weight (g)	7		
Cycle life		500 cycles	
Charge	Standard	35mA(0.1C)×16hrs	
	Rapid	350mA(1C)×1.2hrs or dV=-10mV	
Ambient temperature ()	Standard charge	0 to 45	
	Rapid charge	10 to 45	
	Discharge	-20 to 65	
	Storage	-10 to 45	

(CELL DIMENSIONS)

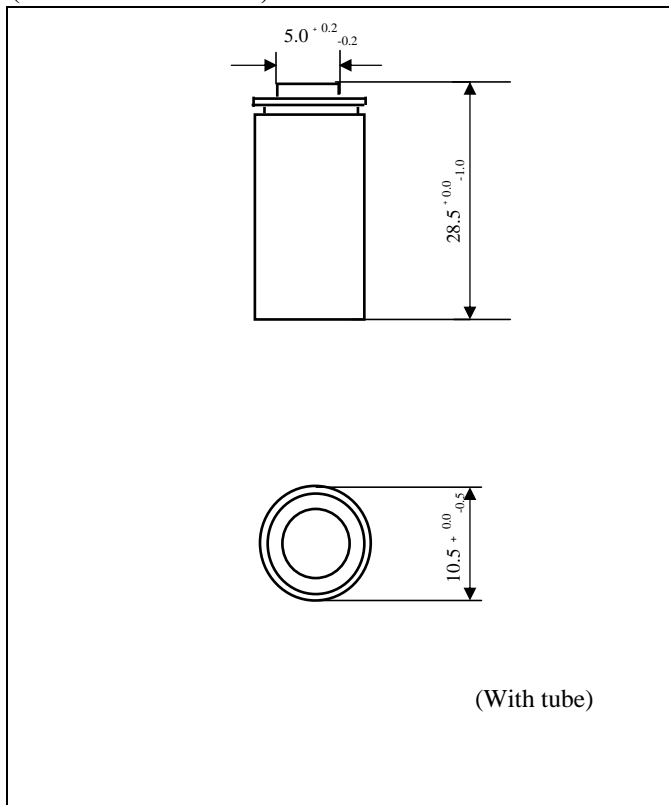

Charge Characteristics

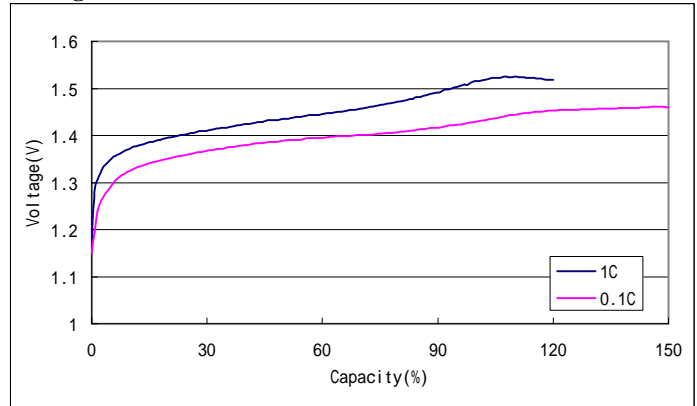

Discharge Characteristics

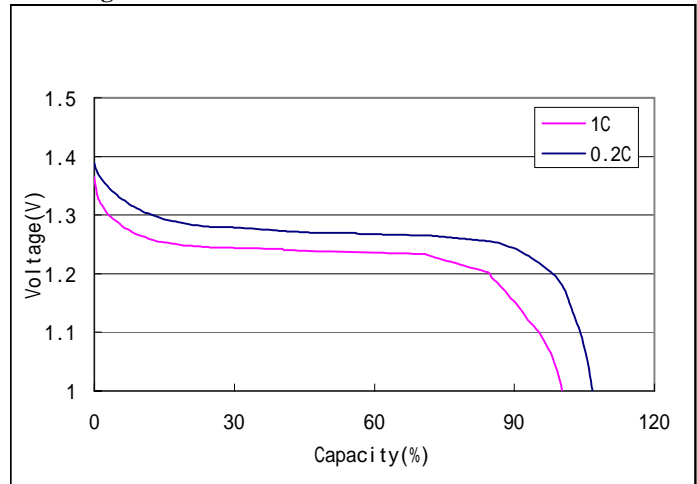

Cycle Characteristics

