

Data Sheet¹

Type Designation	OSL-383562P-01
Dimensions [mm]	
Length (L)	Max.61.6(without Tabs)
Width (W)	Max.35.0
Thickness (T)	Max. 3.65 (delivery status)
	Max. 4.00(after cycling)
Tab Distance	18 +-1
Tab Length	15+-1
Tab Width	4+-0.1
Top Sealing Width	>= 3.0
Weight, approx. [g]	17.0

Electrical Parameter

Nominal Voltage [V]	3.7 (average)
Typical capacity [mAh]	880 (0.2C at 20°C)
Minimum capacity C [mAh]	840 (0.2C at 20°C)
Impedance initial [mΩ]	<70 @ 1kHz at 4.2V
Max. Charge [mA]	840
Max. Charge Voltage [V]	4.20
Max. cont. Discharge [mA]	1680
Discharge Cut off [V]	3.0
Life expectancy 1C / 1C, [20°C Cycles]	500 >80% of initial capacity
Operating temperature [°C]	Charge: 0 to 45 Discharge: -20 to 60
Storage Temperature	6 month at -20 to +35°C

Safety Parameter

UL Recognition	UL1642 - MH45908
Overcharge 3C 4.8V	No fire, no explosion
Overdischarge 300hm 24h	No fire, no explosion
Short Circuit <100mOhm	No fire, no explosion, T<150°C
Heating 130°C 30min	No fire, no explosion
Nailing 2.5D	No fire, no explosion

Delivery Status

Cell Voltage	3.7 – 3.9V
Cell Capacity	50-60%

Printing on the cell

Type	OSL383562P
Date Code yyxxz	yy=year, xx=cw, z=day
	3.7V 840mAh 3.1Wh
	Wheelie Bin

Mechanical Drawing

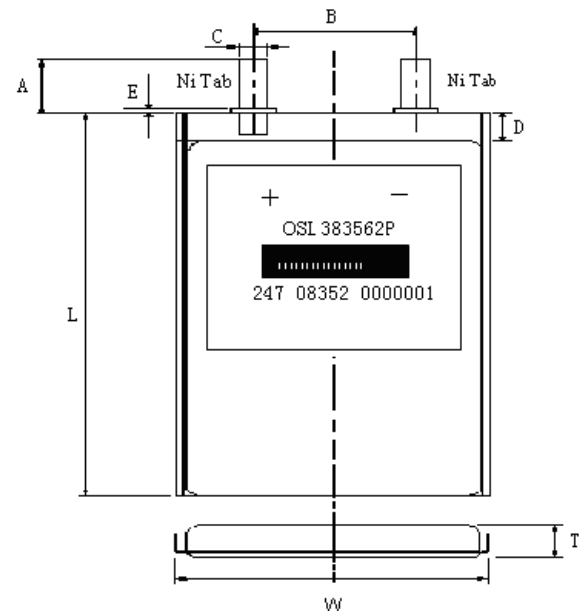

Rate Capability

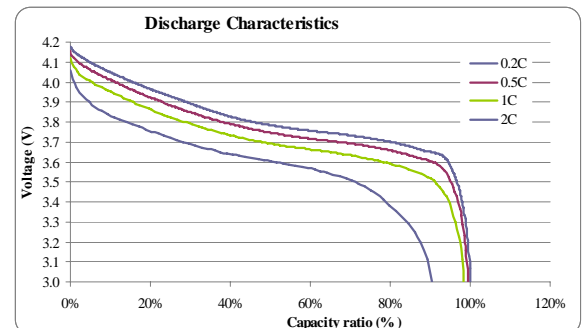

Cycle Life

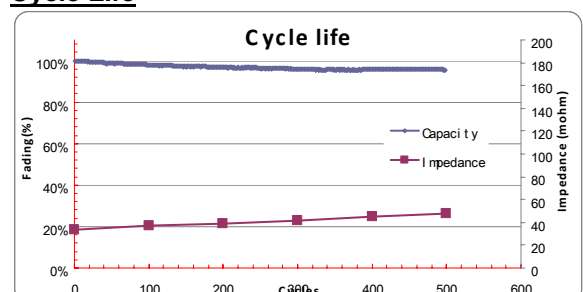

¹ Prior to use read Handling Precaution and Prohibitions for Li-Polymer Batteries Subject to change without prior notice!